



User Manual



1 설치방법

캐비닛 2개~4개를 연결할 경우

- 1 캐비닛 뒤쪽도어의 스크류를 제거하고 도어를 열때 키를 사용하세요
- 2 두번째 캐비닛에 인터넷선을 포함한 배선을 연결하세요

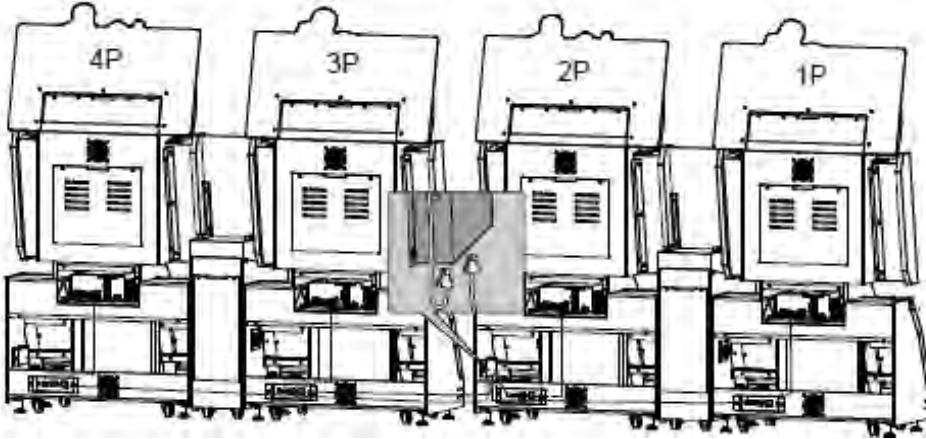

- 3 캐비닛 뒤쪽의 Ac power socket 에 배선을 연결하세요
- 4 전원 on s/w를 켜세요

2 기본설정

TEST 버튼을 눌러서 MAIN MENU 로 들어가세요

- A 캐비닛의 ID와 그룹숫자를 선택하시오

예)캐비닛이 4개라면

MAIN MENU- SYSTEM SETTINGS-CONNECTION SETTINGS

Example of connecting 4 cabinets (viewed from the front of the cabinet):

Cabinet(L)	Cabinet(R)	Cabinet(L)	Cabinet(R)
Connection Setting Group Number 1 ID 1P	Connection Setting Group Number 1 ID 2P	Connection Setting Group Number 1 ID 3P	Connection Setting Group Number 1 ID 4P
Please setup the connection here.		Please setup the connection here.	

- B 코인설정

MAIN MENU- SYSTEM SETTINGS-CONNECTION SETTINGS



C 기타 설정

MAIN MENU- SYSTEM SETTINGS-케비넷연결숫자 설정

MAIN MENU- SYSTEM SETTINGS-게임장 이름 및 위치 설정

MAIN MENU- SYSTEM SETTINGS-SOUND SETTINGS - 데모사운드설정

D 볼륨 조정







MAIN MENU- SYSTEM SETTINGS-VR ADJUSTMENTS - 볼륨 자동설정

BASE PARAMETERS ADJUSTMENTS - PRESS : 모터사이클의 소리를 조정할수있다.

E 완료

3 캐비닛 소개

A 부속 부품

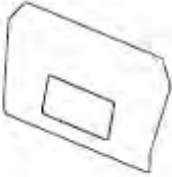
Accessories	Picture	Quantity	checking column.
AC cord		2	
Interent wire		1	
Operator's manual		1	
Controlling panel key		1	
Coin slot key		1	
SR 2 card		(Additional purchase)	
Cash box acrylic		1	

B 제품 규격
정면

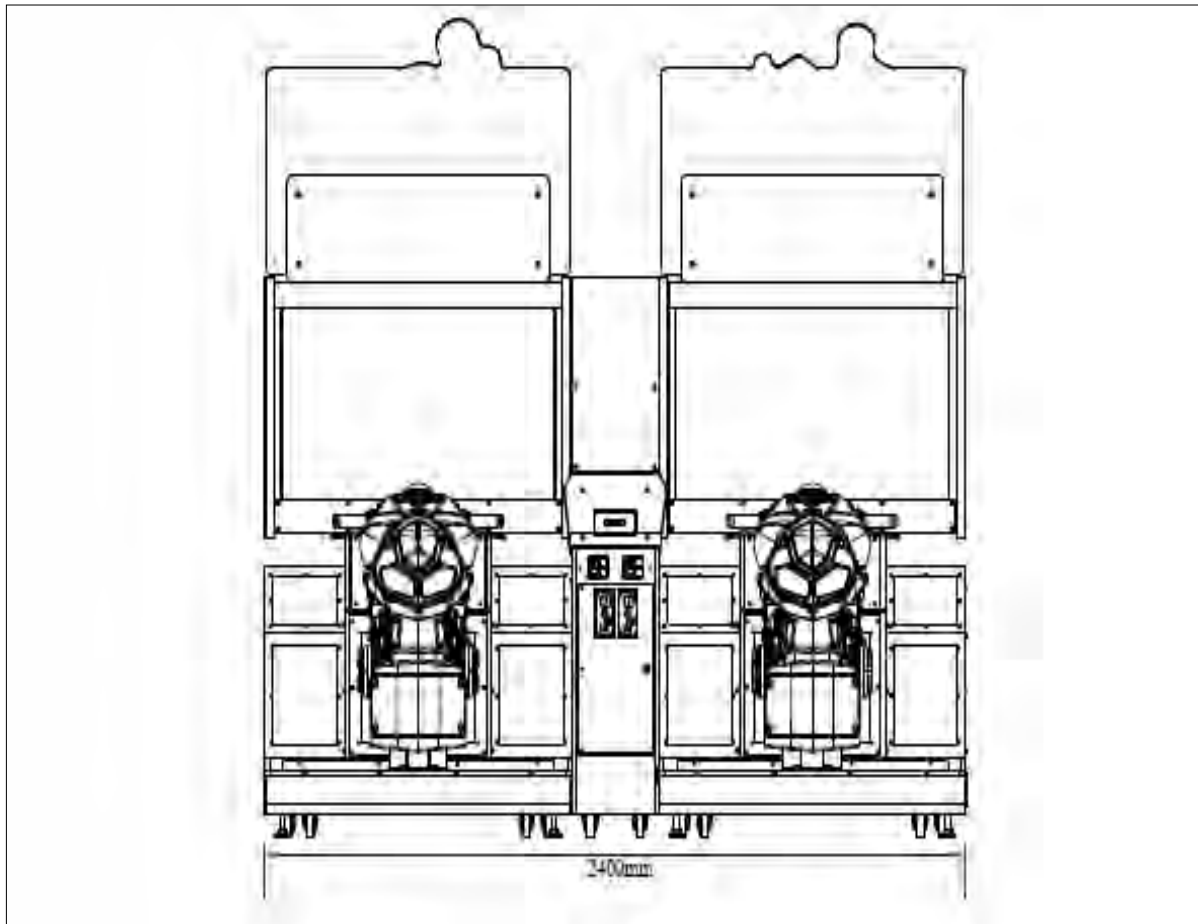

측면

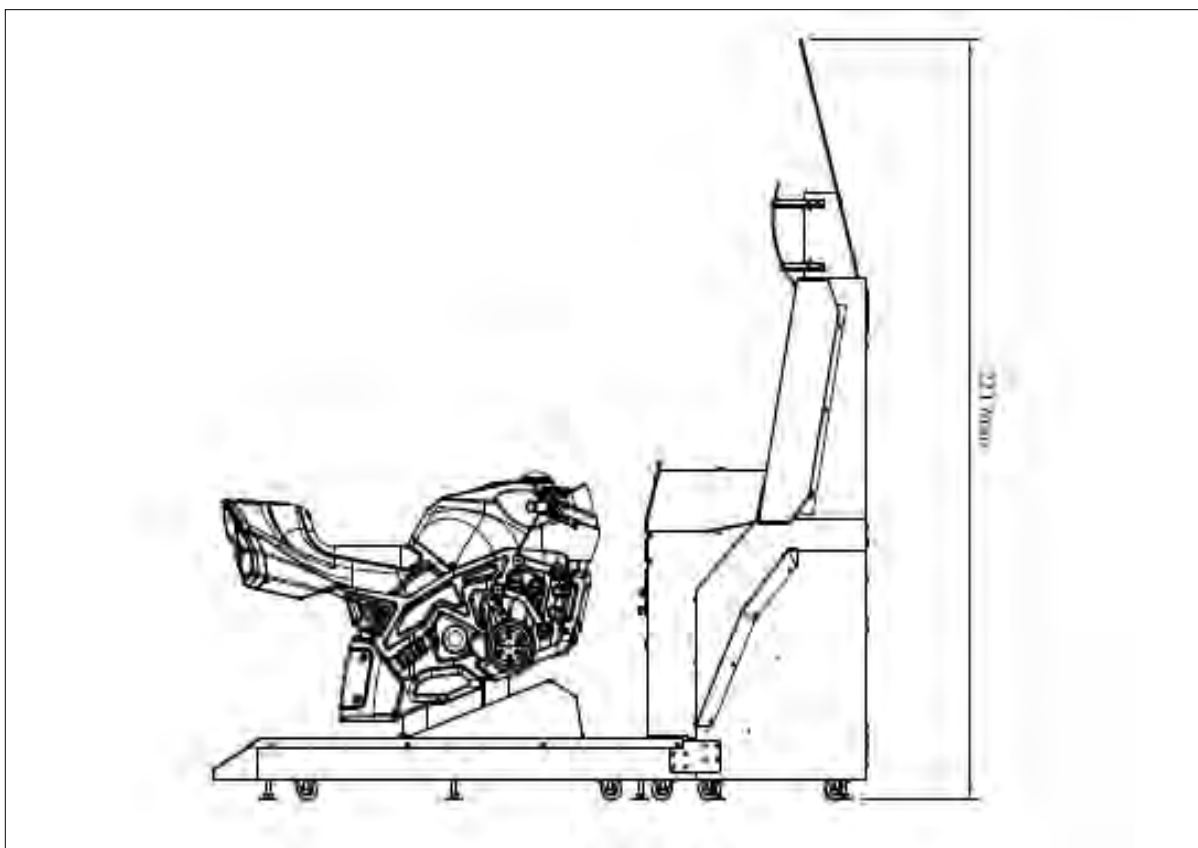

Category	Items	Specification
Concrete item	Size of the cabinet	2400(W)mm x 2105(D)mm x 2217(H)mm
Power	Power	AC220V (50Hz) / AC110V (60Hz)
	Total Power	cabinet 900W
Main cabinet	Cabinet	E3000, AC220V
	Power amplifier	AMP set of full range, 100W, AC220V
Buttons and control	Oil tank of the motorcycle	Buttons: UP, DOWN, LEFT, RIGHT, S/BOOST, and the sensor
	Vehicle body	Left brake, right brake, throttle, and leaning control to the left and right side
	Coin box	Coin slot, counter, test, services, and the volume
Lights	Oil tank of the motorcycle	Buttons (UP, DOWN, LEFT, RIGHT, and S/BOOST)
	The rear light of the motorcycle	Brake light x1, side light x2, underneath light x2
	Main part	Flash light x3, bass light x4
	Billboard	Billboard light x4
	Sensor	Sensor light x1
Fan	Power	AC220V (50Hz)
Card reader	Interface	USB interface
	Cards	IC game chip card
Internet	Standard	IEEE 802.3 (10BASE-T) · IEEE 802.3u (100BASE-TX)
	Transfer rate	10/100 Mbps
	Maximum number of connected cabinets	4
Screen	Type	LCD
	Size	42 inches (16:9)
	Power	AC110V - AC220V (50Hz/60HZ)
Loudspeaker	Size/Resistance/Power	Mid to high (on both sides of the screen) : 4inches, 4 Ohm / 25W Bass (in the bottom of the screen): 8inches, 4 Ohm / 100W
Environment	Operating temperature	0-40° C
	Storing temperature	-10~80° C
	Relative moisture	< 85% none coagulation status

C 부품 명칭

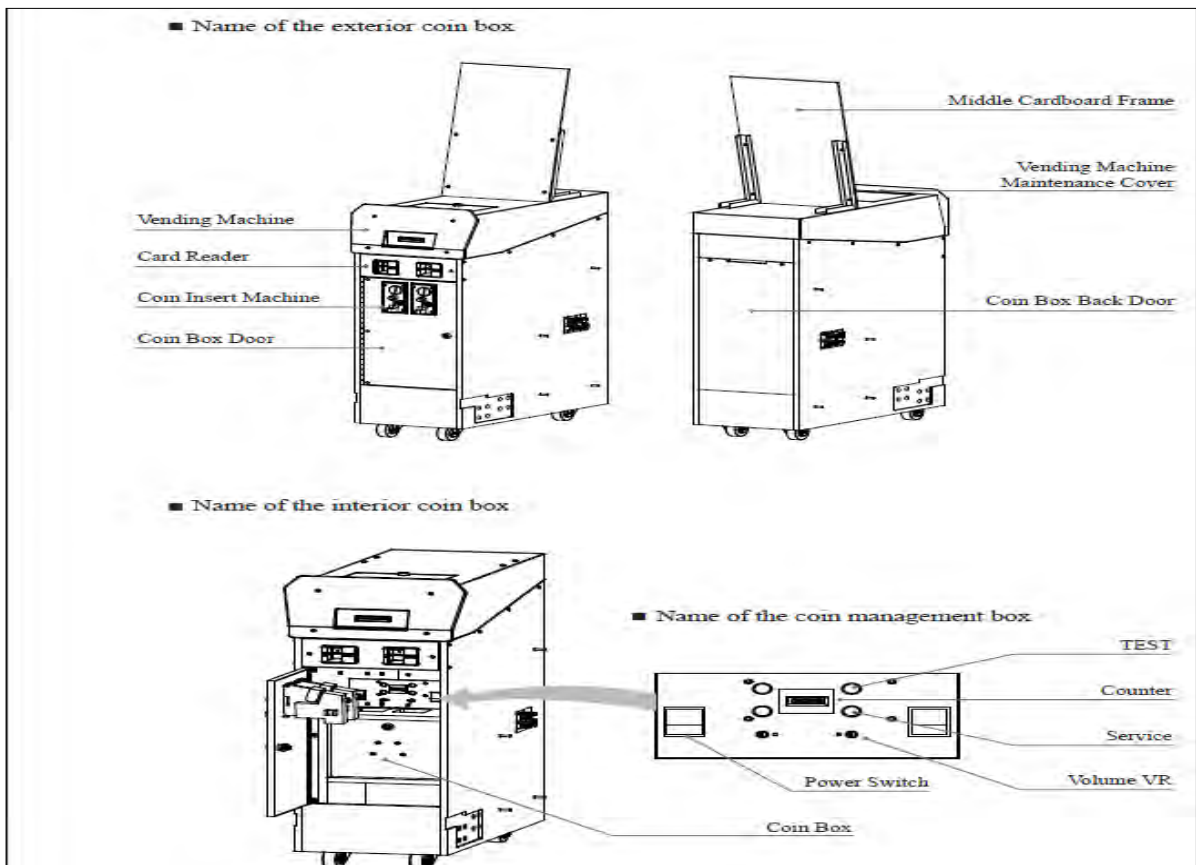
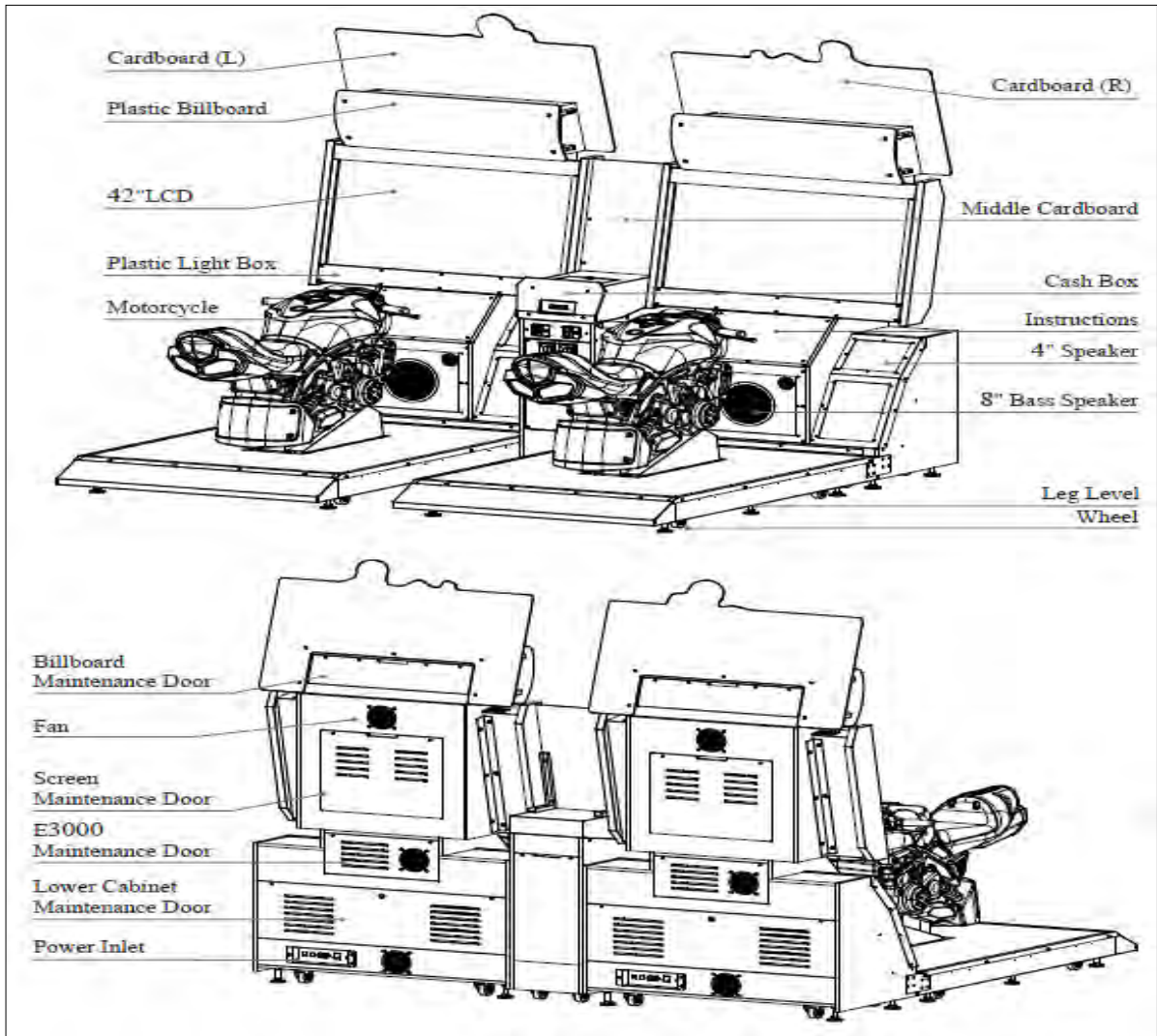

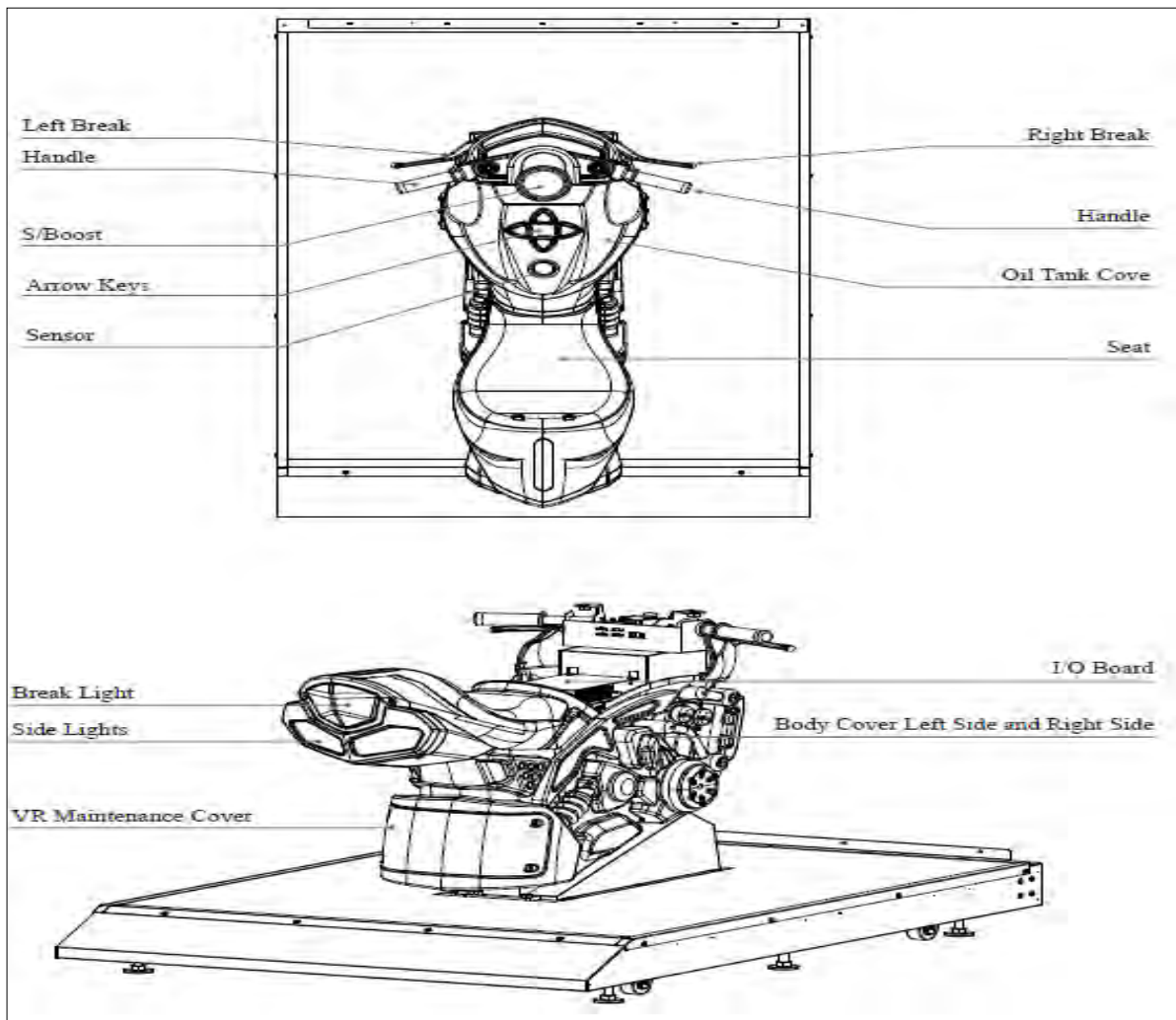

■ Name of the interior cabinet

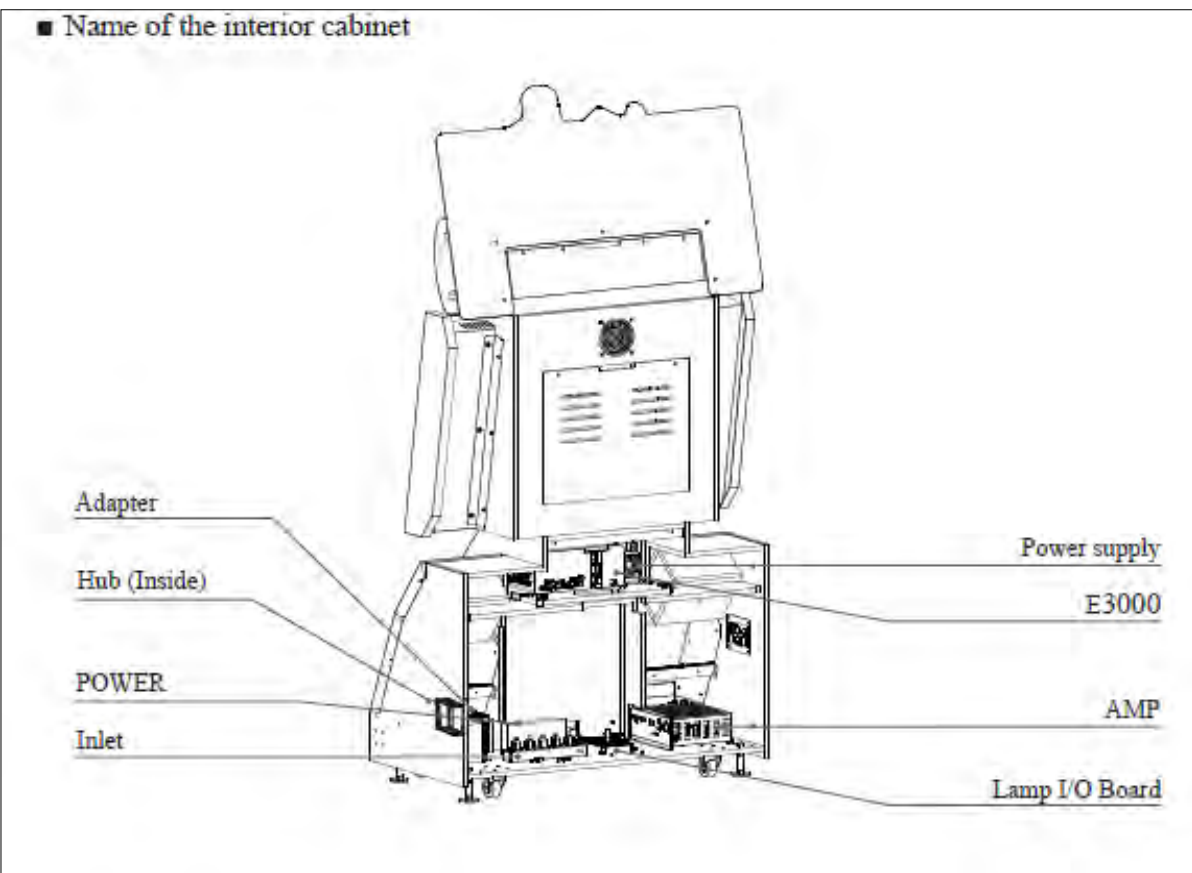

4 게임설명

A 게임모드 (요금 1PLAY 500~1000원)

- MULTI-PLAYER GAME 멀티게임 - 4인용까지 가능
- STORY MODE 원스토리를 경험할수있는 모드
- TIME ATTACK 싱글게임에서 다른플레이어의 기록과 경쟁하는 모드
- SURVIVAL 승자만 추가 게임을 할 수 있는 모드

B 아케이드 스타일

좌우 앞으로 속임등의 센서를 감지한다.

C 부트 시스템

순간적인 스피드를 증가시킨다.

D 모션 센서

스피드를 증감시킨다.

E 카드

레이싱데이터와 차량모델이 카드에 저장된다.



F 세부방법

S 버튼을 누르면 부스터가 작동됨



모터사이클을 왼쪽/ 오른쪽으로 움직이면
게임화면의 모터사이클도 동일하게
움직인다.



몸을 앞으로 구부리면 속도가 증가된다.



▼ 버튼을 누르면 화면모드 /

싸이클모드로 전환된다.

방향튼을 할때 브레이트를 누르면

드리프트를 할수있다.

큰튼은 우측 브레이크

작은튼은 왼쪽 브레이크를 사용한다.

결승점에서 앞바퀴를 들수있다.

싱글플레이시 UP/DOWN/LWFT/RIGHT
BREAK를 동시에 누리면 모드변경이
가능하다.

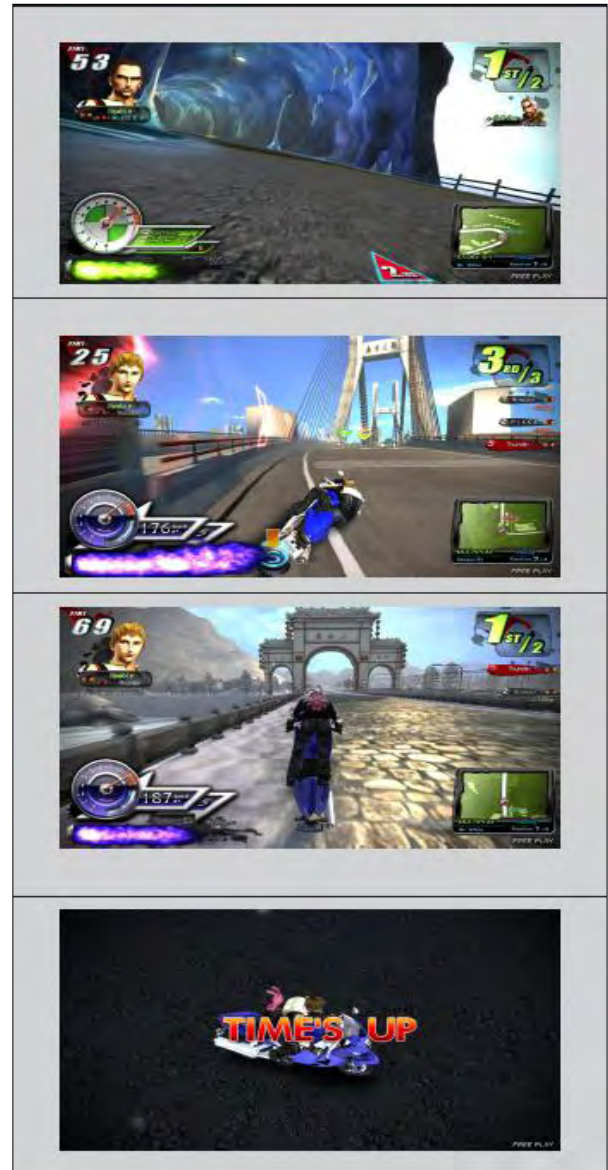

5 게임화면 설명

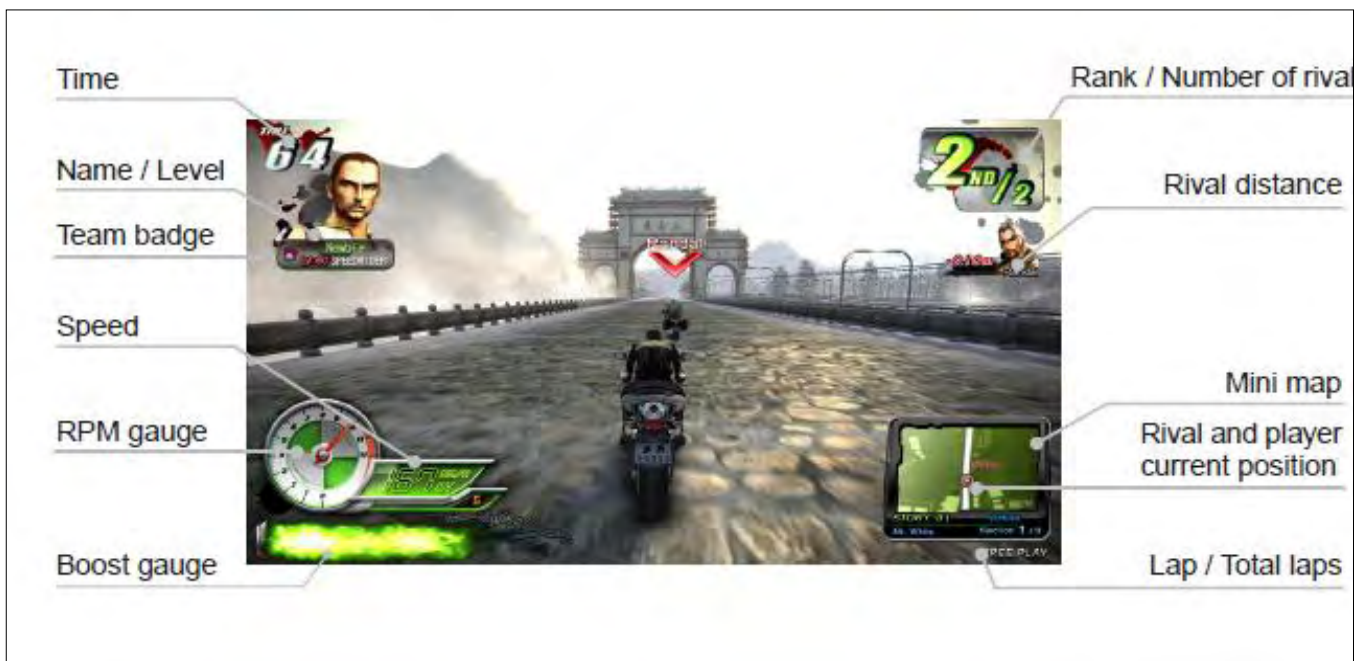

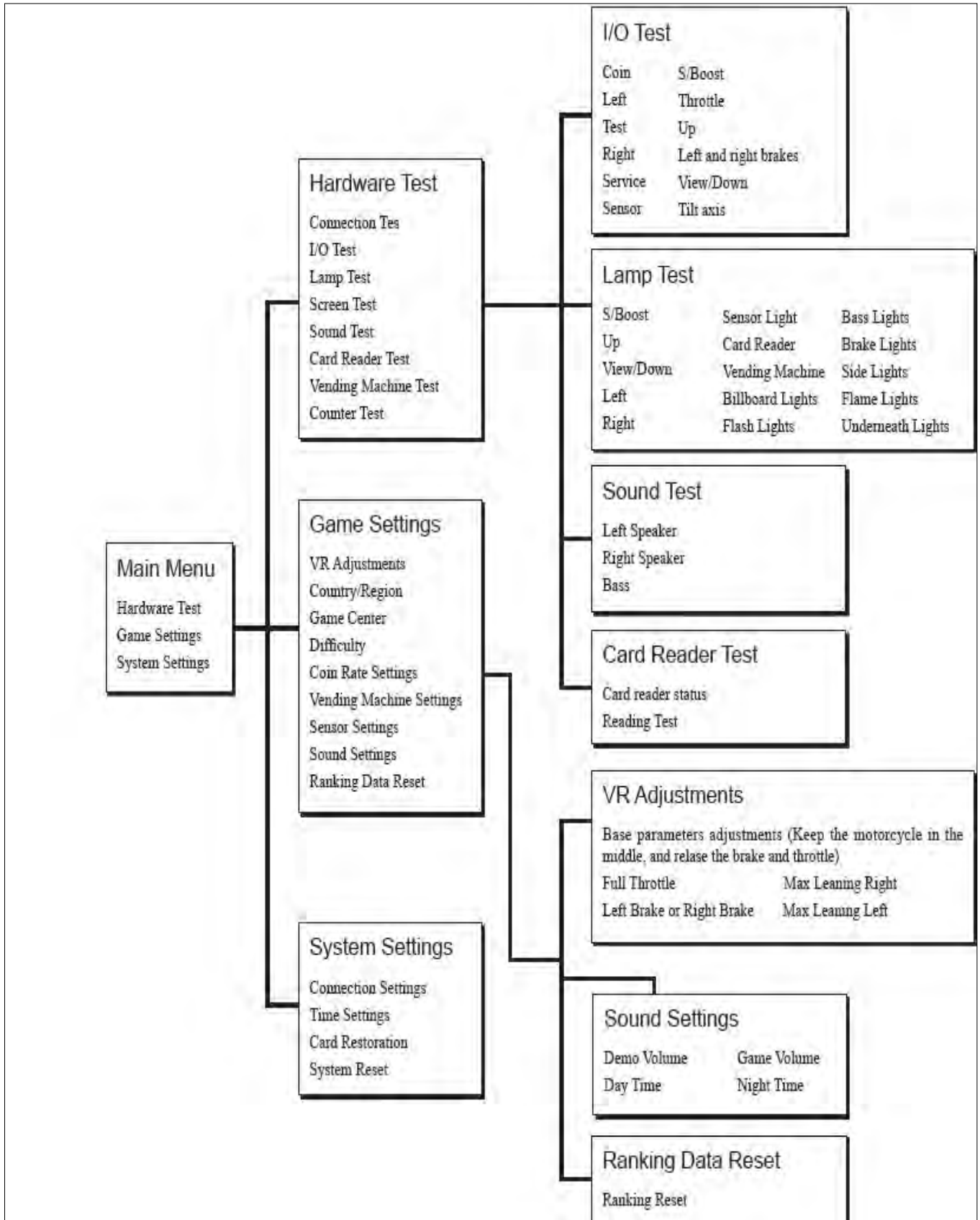

7 카드 이용내용

카드는 기본적으로 게임 데이터가 저장되며 아래와 같이 최초에 카드 NAME을 지정하여 사용한다.

카드는 무상제공 OR 별도 판매로 한다.



8 기기내부 사진

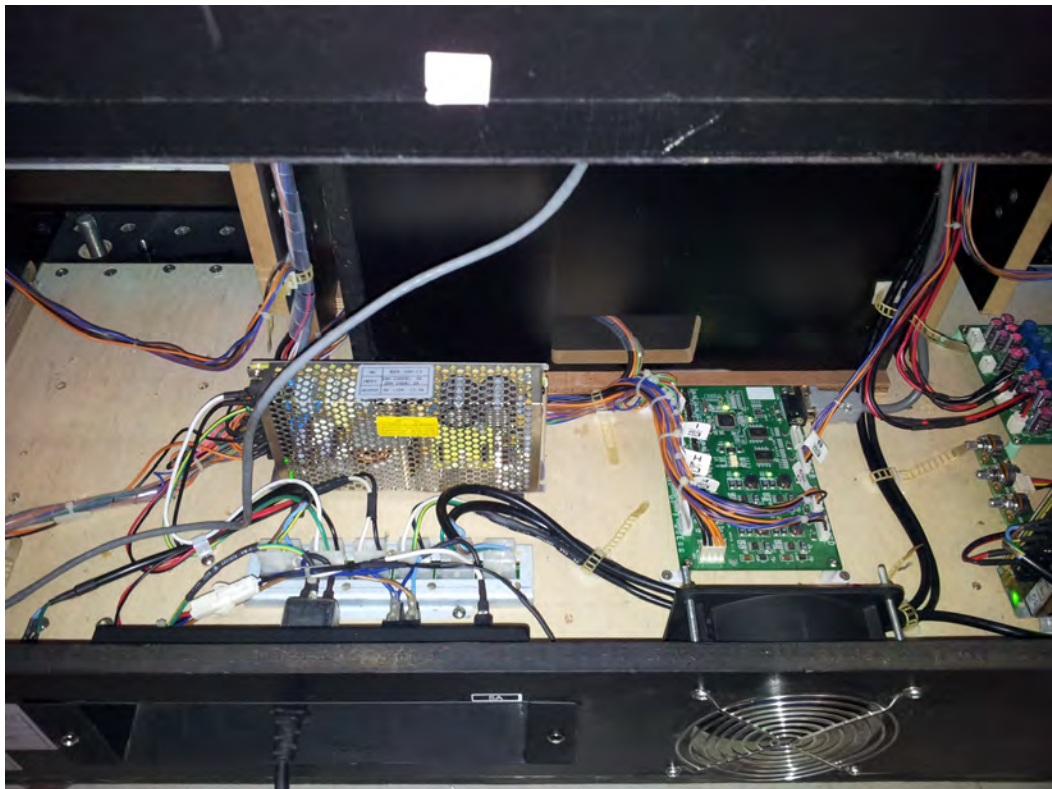

※ SYSTEM SETTING

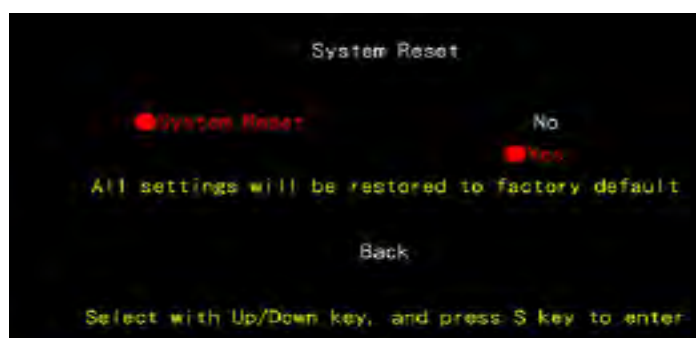

※ GAME SETTING

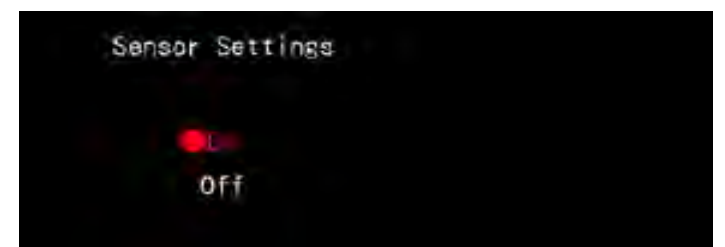
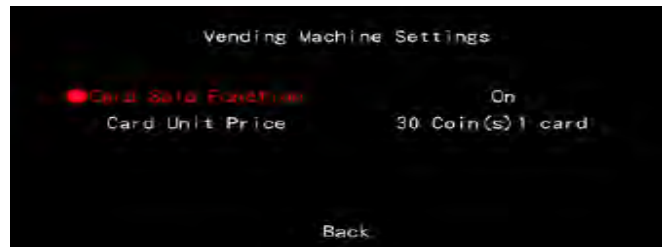
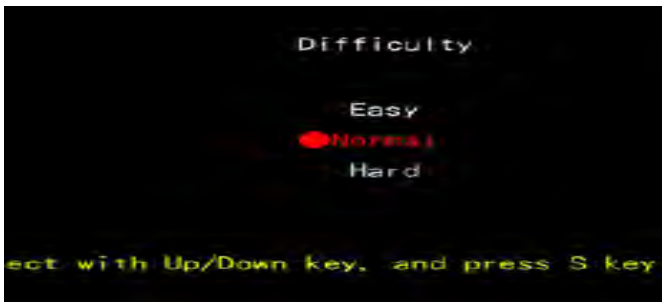
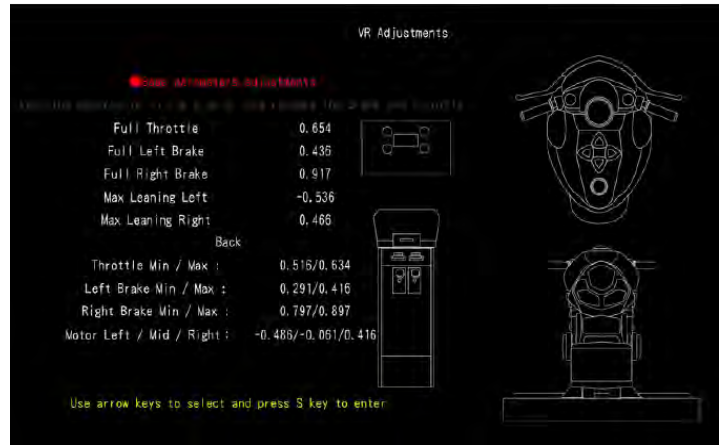
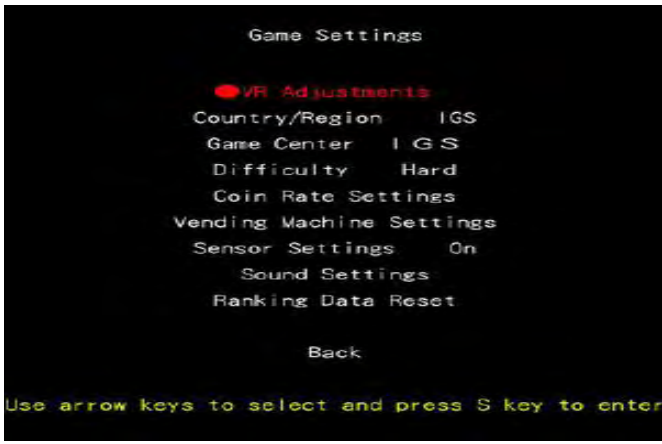

※ HARDWARE TEST

I/O Test

Coin 0
 Test
 Service
 S/Boost
 Up
 View/Down
 Left
 Right
 Sensor

Throttle -0.068
 Left Brake -0.160
 Right Brake -0.220
 Tilt Axis 0.004



Press S key + Up key to exit

Lamp Test

- Auto Test
- S/Boost
- Up
- View/Down
- Left
- Right
- Sensor Light
- Card Reader
- Vending Machine
- Billboard Lights
- Flash Lights
- Bass Lights
- Frame Lights
- Brake Lights
- Side Lights
- Underneath Lights



Back

Use arrow keys to select and press S key to enter

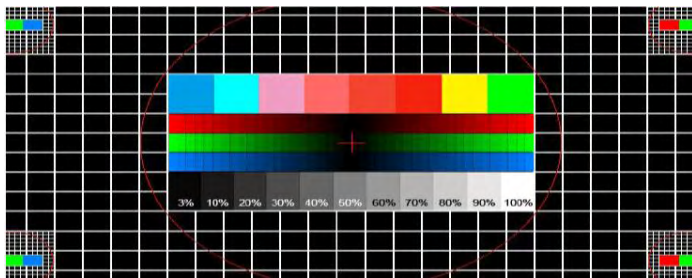

Sound Test

- Left Speaker Test
- Right Speaker Test
- Bass Test

Back

Use arrow keys to select and press S key to enter

Card Reader Test

Card Reader Status ... Installed(1.0)
 ● Reading Test ... Checking
 High Potential Signal
 Low Potential Signal

Back

Select with Up/Down key, and press S key to enter

Vending Machine Test

Vending Machine Status ... Sufficient value in the card
 ● Card Dispensing Test
 Replenish Card

Back

Select with Up/Down key, and press S key to enter

Counter Test

● Counter 0

Press S key and the counter value will go up by 5 times

Back

Select with Up/Down key, and press S key to enter

<<1P>>

<< E3000 Host >>

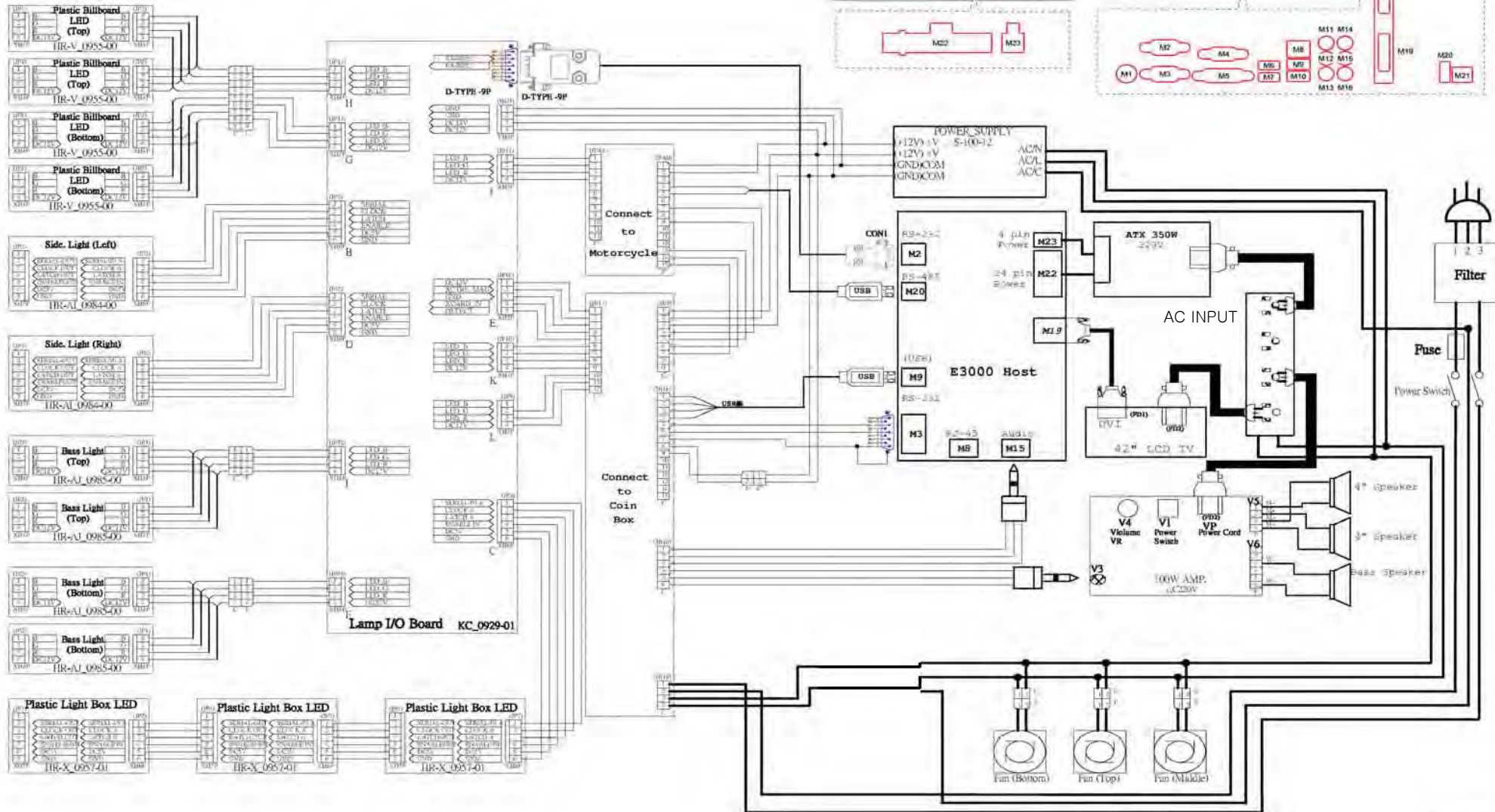

<<Coin Box>>

